



Model(s):

HD-7P Four-Post Lift
NARROW / HIGH LIFT / SHORT RUNWAYS

HD-7W (REV. M) Four-Post Lift
WIDE / HIGH LIFT / SHORT RUNWAYS

The space saving HD-7P and HD-7W (Rev. M) four-post lifts provide high lifting with short runways. Both models maximize valuable floor area and help turn your garage space into the perfect storage and service area for cars and trucks, ATVs, snowmobiles, jet skis, golf carts, boats or just about anything else that needs to be off the ground. The HD-7W (Rev. M) features a wider drive-thru clearance to accommodate super-wide vehicles; the narrower HD-7P accommodates most standard passenger cars and light trucks and fits in tighter spaces. If you've got at least a standard 8-foot ceiling you'll be able to make use of the wasted vertical space above your car. An optional caster kit allows you to roll the lift outside or wherever best suits your needs.



Optional Drip Trays

Optional RJ-45 Bridge Jack

Optional Caster Kit

Features:

- 7,000 pound lifting capacity
- Extended lifting height and short runways
- Electric/hydraulic power system
- Internal "Anti-Sway" slider blocks in each column
- Features heavy-duty 3/8" aircraft cable
- Multi-position safety locks in each column
- Ramps feature non-skid surface
- Runways include rail-kit for optional accessories
- Single hydraulic cylinder underneath runway
- Oversized self-lubricating cable rollers
- Rugged 1-1/4" roller axles
- Adjustable lock ladders
- Push-button pneumatic safety release
- Optional 4500-lb. capacity jack available (Model RJ-45)

COLOR OPTIONS / SPECIAL COLORS AVAILABLE UPON REQUEST



Graphite Black



Classic Blue



Seca Red



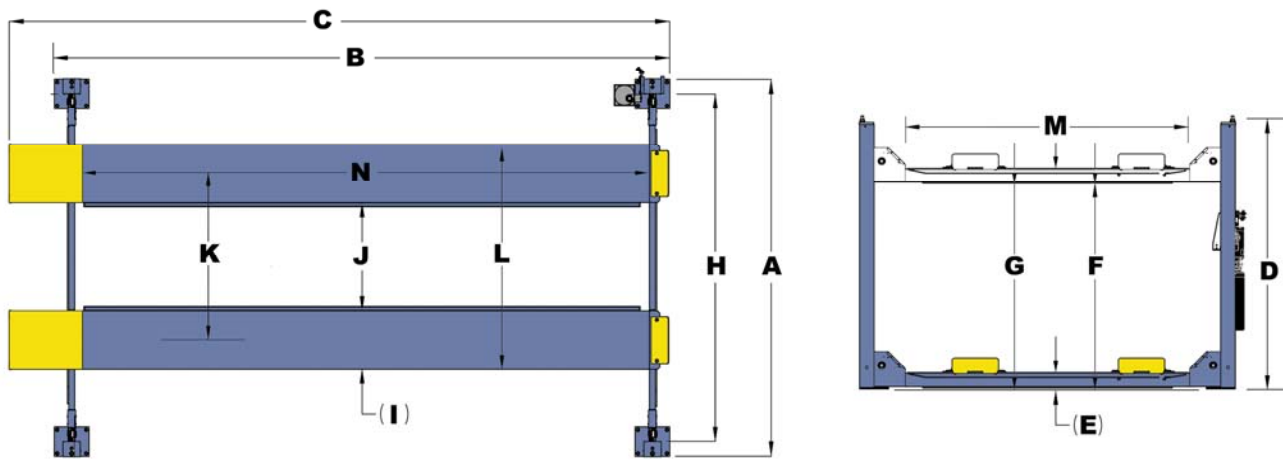

MODEL	HD-7P	HD-7W (Rev. M)
Style	Short Runway / Narrow / High Lift	Short Runway / Wide / High Lift
Lifting Capacity*	7,000 Lbs. / 3175 Kg.	7,000 Lbs. / 3175 Kg.
*Max Capacity / Front Axle	3,500 Lbs. / 1588 Kg.	3,500 Lbs. / 1588 Kg.
*Max Capacity / Rear Axle	3,500 Lbs. / 1588 Kg.	3,500 Lbs. / 1588 Kg.
A - Overall Width	99-3/4" / 2534 mm.	110-1/4" / 2800 mm.
B - Outside Length	174" / 4420 mm.	174" / 4420 mm.
C - Overall Length	189" / 4802 mm.	189" / 4802 mm.
D - Height of Columns	100" / 2540 mm.	100" / 2540 mm.
E - Min. Runway Height	4-1/2" / 114 mm.	4-1/2" / 114 mm.
F - Max. Rise	82" / 2083 mm.	82" / 2083 mm.
G - Max. Lifting Height	86-1/2" / 2197 mm.	86-1/2" / 2197 mm.
H - Width Between Posts	89-3/4" / 2280 mm.	100-1/4" / 2,555 mm.
I - Runway Width	19" / 483 mm.	19" / 483 mm.
J - Width Between Runways (*) NARROW	37-1/2" / 952 mm.	37-1/2" / 952 mm.
J - Width Between Runways (*) WIDE	N/A	44-3/8" / 1127 mm.
K - Runway Centerline (*) NARROW	56-1/2" / 1435 mm.	56-1/2" / 1435 mm.
K - Runway Centerline (*) WIDE	N/A	63-3/8" / 1610 mm.
L - Outside Edge of Runways (*) NARROW	75-1/2" / 1918 mm.	75-1/2" / 1918 mm.
L - Outside Edge of Runways (*) WIDE	N/A	82-3/8" / 2092 mm.
M - Drive-Thru-Clearance	76-1/2" / 1943 mm.	86-1/2" / 2197 mm.
N - Length of Runways	164" / 4166 mm.	164" / 4166 mm.
Min. Wheelbase @ Rated Capacity	115" / 2921 mm.	115" / 2921 mm.
Min. Wheelbase @ 75% Capacity	100" / 2540 mm.	100" / 2540 mm.
Min. Wheelbase @ 50% Capacity	85" / 2159 mm.	85" / 2159 mm.
Min. Wheelbase @ 25% Capacity	70" / 1778 mm.	70" / 1778 mm.
Locking Positions	15	15
Lock Spacing	Every 4" / 102 mm.	Every 4" / 102 mm.
Lifting Time	35 Seconds	35 Seconds
Standard Motor (*)	220 VAC / 60 Hz. 1Ph.	220 VAC / 60 Hz. 1Ph.

* This dimension may be limited with the addition of rolling jacks. See rolling jack specifications on separate page.

** Special Voltages Available Upon Request

The design, material and specifications are subject to change without notice.